

## Sonitron Automotive Piezo components

### SAP-1302 series Backup alarm

The 1302 series of piezo alarms generate an acoustic intermittent loud tone and are installed at the back of a car, truck, tractor, jeep, golf-trolley, ... or any other vehicle that can move in reverse at any moment, thus alerting people that are approaching the vehicle.

The 1302 series are tested for use in all weather conditions and have a lifetime in continuous use of more than **1000 hours**, this unique patented technology is used now for more than 20 years in the most extreme conditions and critical applications. (Nato, Airbus, Volvo, avionics, Bombardier railways, VDO, etc...)

A very low current consumption permits the electrical connection of the alarm to the reversing lights of the vehicle.

Installation of the reverse drive piezo alarm is realised in only one hour by anybody and does not require special skills. Adapted mounting for models on request.

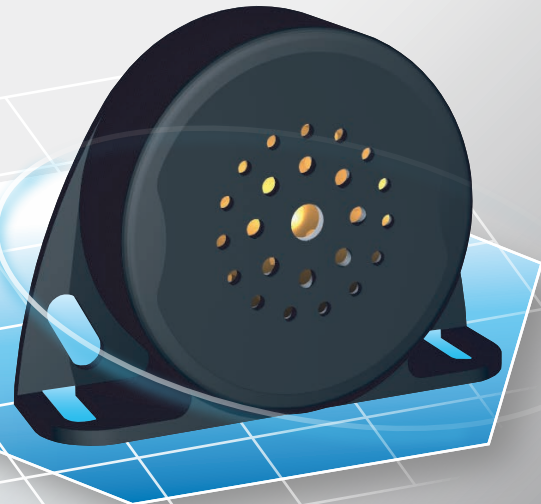

*Automotive* Design



## ADVANTAGES & APPLICATIONS

### ADVANTAGES :

- Very low current consumption
- Dust tight, shock and water resistant (IP67)
- Low frequency (large travelling distance of audible wavelength)
- No magnetic field (EMC)
- Robust fibre reinforced PBT housing
- High lifetime in continuous function
- Easy mountable design
- Multi voltage application (12/24/48Vdc)

### APPLICATIONS :

- Van
- Fork-lift
- Lorry
- Bus
- Light commercial vehicle
- Car
- Light truck
- Garbage truck
- Electric vehicles (golf, airport, warehouse, ...)
- Military vehicles

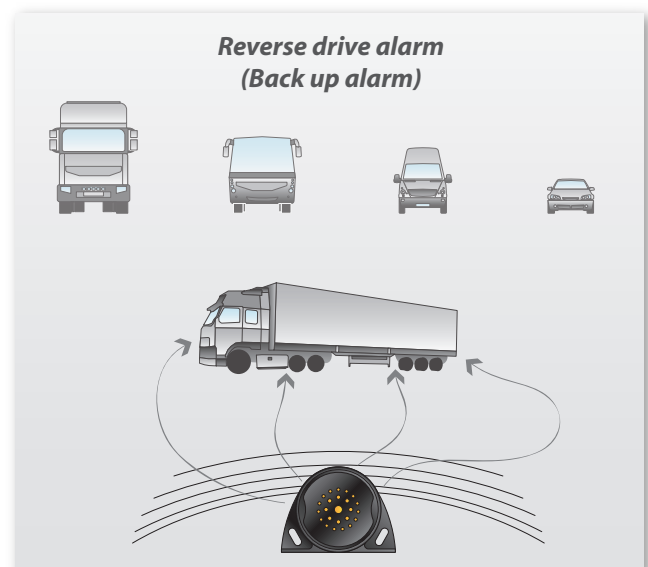

## SPECIFICATIONS

MODELS	SAP-1302-A	SAP-1302-B	SAP-1302-C	SAP-1302-D
<b>Operating voltage:</b>	12/24 Vdc	12/24 Vdc	12/24/48 Vdc	12 Vdc**
<b>Frequency (+/-15%):</b>	1600 Hz (1Hz intermittent)	1600 Hz (1Hz intermittent)	1250 Hz (1Hz intermittent)	2500 Hz (1Hz intermittent)
<b>Current consumption:</b>	<b>12Vdc: 145 mA</b> (avg.) <b>24Vdc: 70 mA</b> (avg.)	<b>12Vdc: 140 mA</b> (avg.) <b>24Vdc: 65 mA</b> (avg.)	<b>145 mA</b> (avg.)	<b>15 mA</b> (avg.)
<b>SPL@1.2m:</b>	<b>112 dBA</b> (+/- 4 dB)	<b>107 dBA</b> (+/- 4 dB)	<b>97 dBA</b> (+/- 4 dB)	<b>87 dBA</b> (+/- 4 dB)
<b>Life time (@21°C):</b>	>1000 hours***	>1000 hours***	>1000 hours***	>1000 hours***
<b>Case material:</b>	PBT (UL rating: 94HB)	PBT (UL rating: 94HB)	PBT (UL rating: 94HB)	PBT (UL rating: 94HB)
<b>Standard color of case:</b>	Black	Black	Black	Black
<b>Terminal material:</b>	(F2)Fast-on or 30cm cable 2x1.5mm <sup>2</sup>	(F2)Fast-on or 30cm cable 2x1.5mm <sup>2</sup>	(F2)Fast-on or 30cm cable 2x1.5mm <sup>2</sup>	(F2)Fast-on or 30cm cable 2x1.5mm <sup>2</sup>
<b>Storage Temp. range:</b>	-40°C/+85°C	-40°C/+85°C	-40°C/+85°C	-40°C/+85°C
<b>Operating Temp. range:</b>	-40°C/+85°C	-40°C/+85°C	-40°C/+85°C	-40°C/+85°C
<b>Weight:</b>	230 g	230 g	210 g	230 g

- \*\*Output voltage depending: min. 5 Vdc=76 dBA, max. 16Vdc=91 dBA.
- \*\*\*Lifetime: more than 1000 hours in continuous use,  
(Voltage: 12 Vdc ; T ambient: 21°C ; Humidity: 40 % ; Free air).

"Models on request" can be designed for this alarm construction!

Same housing other alarm tone:   - pulse tone  
  - continuous tone  
  - sweep tone, ...

Contact [Support@sonitron.be](mailto:Support@sonitron.be)



Sound pressure level vs. operating voltage

**SAP-1302-A**

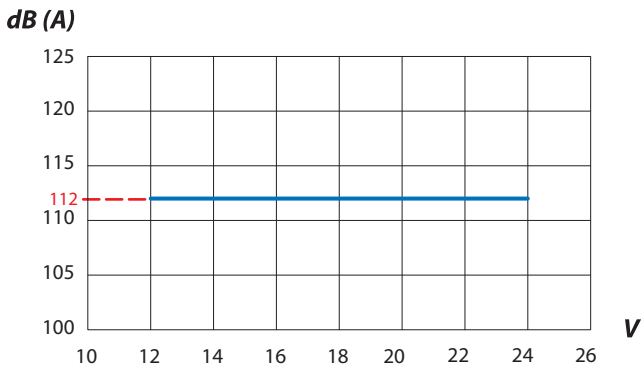

**SAP-1302-B**

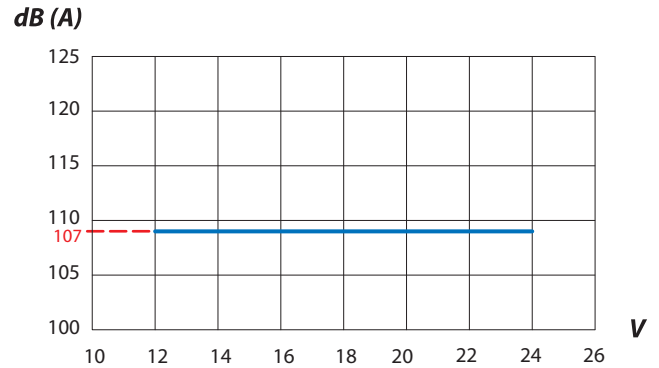

**SAP-1302-C**

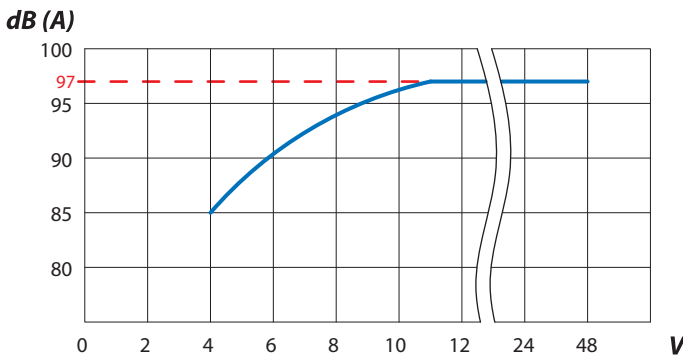

**SAP-1302-D**

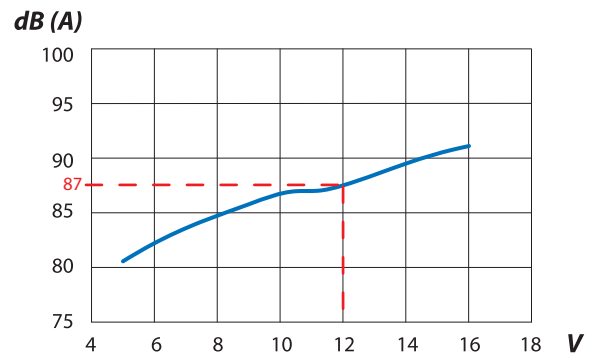

All measurements are made @ 12Vdc @1.2 meter in free air @ 21 °C.

**LIST OF AVAILABLE PRODUCT TYPES**

SAP-1302-A-F2	(Fast-on F2, tinned brass)
SAP-1302-A-W	(standard cable length=30cm)
SAP-1302-B-F2	(Fast-on F2, tinned brass)
SAP-1302-B-W	(standard cable length=30cm)
SAP-1302-C-F2	(Fast-on F2, tinned brass)
SAP-1302-C-W	(standard cable length=30cm)
SAP-1302-D-F2	(Fast-on F2, tinned brass)
SAP-1302-D-W	(standard cable length=30cm)

## Dimensions (in mm)

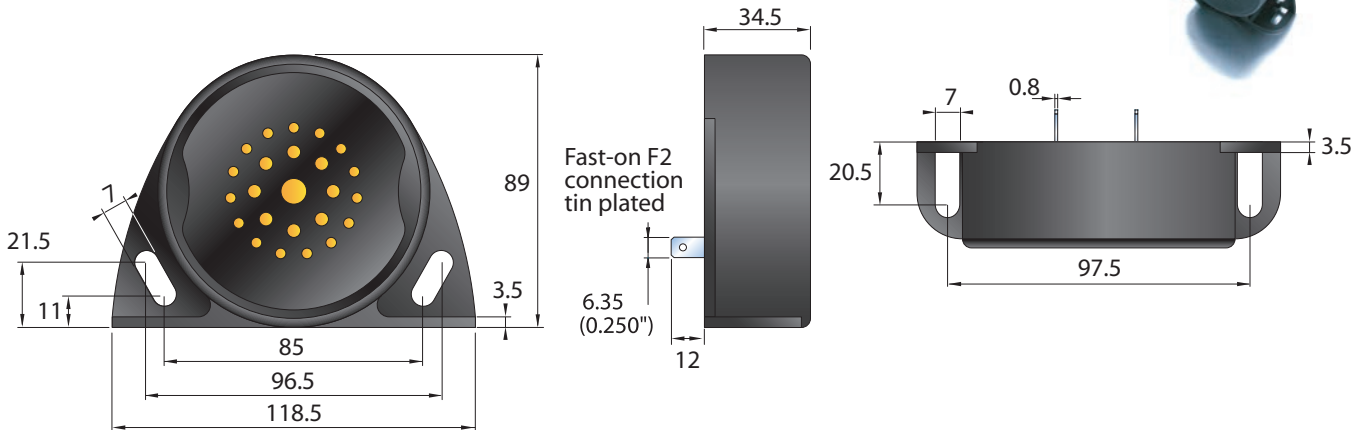

**SAP-1302-A-B-C**  
Fast-on position

**Cable version**  
Standard cable length: 30 cm  
- white: pos(+)  
- blue: neg(-)

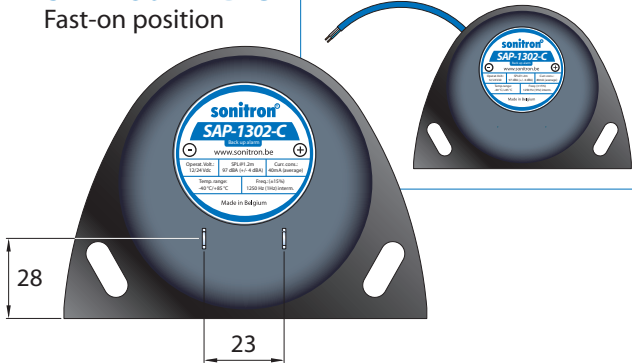

**SAP-1302-D**  
Fast-on position

**Cable version**  
Standard cable length: 30 cm  
- white: pos(+)  
- blue: neg(-)

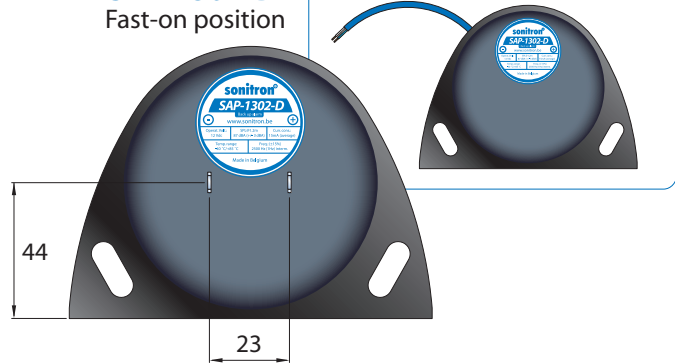

## Mounting guidelines

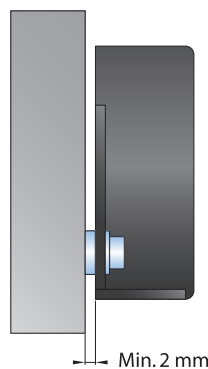
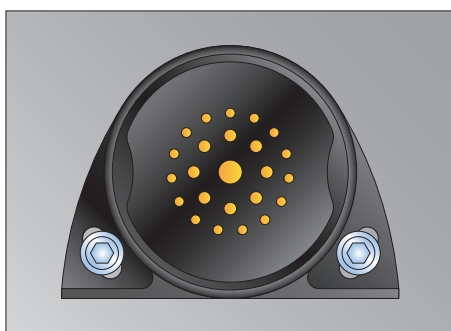

2x M6 screw, nut and washer recommended for mounting

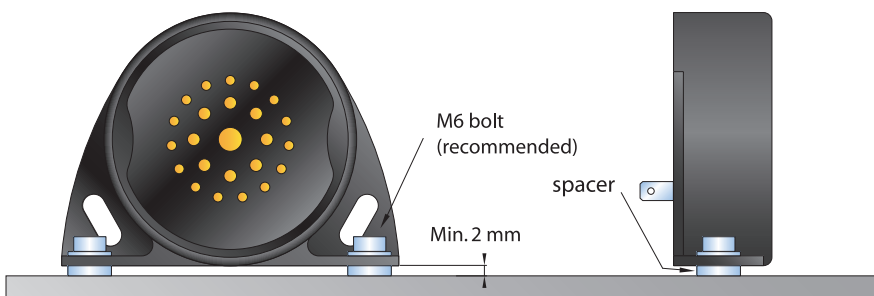

### Packaging

One piece per box.

